

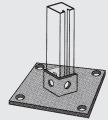

# G-STRUT® & WIZARD® ACCESSORIES

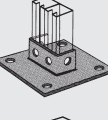
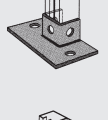
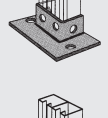
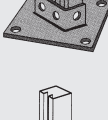
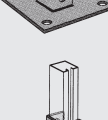
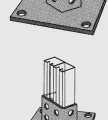
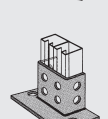
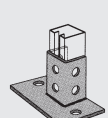
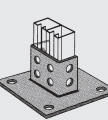
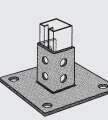

## Wizard® Misc. & Special Fittings

-  G-619
-  G-619-A
-  G-619-FL
-  G-619-A-FL
-  G-619-A-SQ
-  G-619-SQ
-  G-620
-  G-620-A
-  G-620-A-FL
-  G-620-FL
-  G-620-A-SQ
-  G-620-SQ

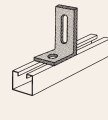
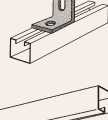
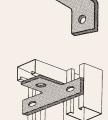
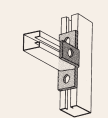
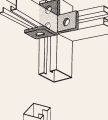
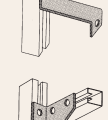
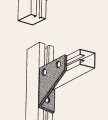
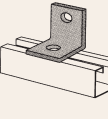
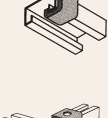
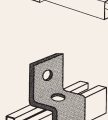
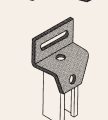
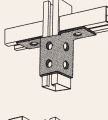
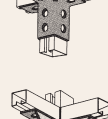
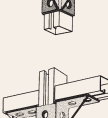

## Wizard® Inserts & Endcaps

- Continuous Concrete Inserts
- G-382
- G-132
- G-102
- G-582
- TYPE A
- TYPE B

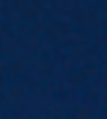
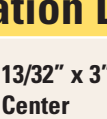
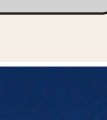

## Wizard® Misc. & Special Fittings

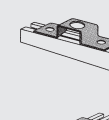
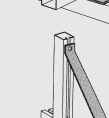
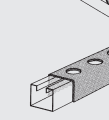
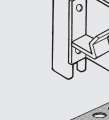
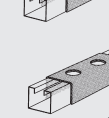
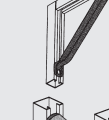
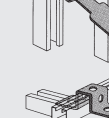
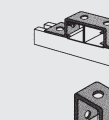
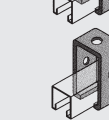
-  G-336 Series
-  G-337
-  G-338 Series
-  G-339
-  G-340
-  G-341 Series
-  G-3410 Series
-  G-342-1,2
-  G-343-1,2
-  G-344
-  G-346 Series
-  G-347
-  G-348
-  G-349
-  G-350
-  G-351
-  G-352
-  G-353-L

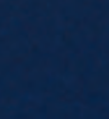
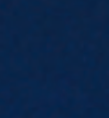
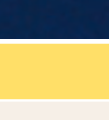
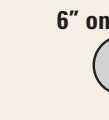

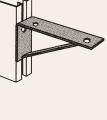
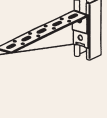

## Wizard® "U" Fittings & Braces

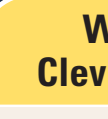
-  G-601 Series
-  G-602 Series
-  G-603 Series
-  G-604-1
-  G-605 Series
-  G-606 Series
-  G-607
-  G-608 Series
-  GTB-608 Series
-  G-609 Series
-  G-610
-  G-611
-  G-611-1
-  G-613

## Wizard® Shelf Brackets

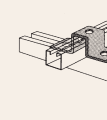
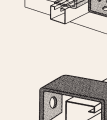
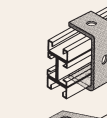
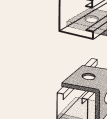
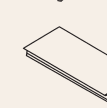
-  GT-619 Series
-  GT-620 Series
-  GT-621 Series
-  GT-622 Series
-  GT-623 Series
-  GT-625 Series

## Wizard® Clevis Fittings

-  G-617 Series
-  G-618
-  G-622
-  G-623
-  G-624
-  G-625
-  G-CLPL
-  G-CLPG











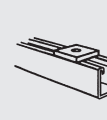

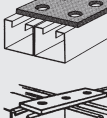
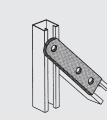
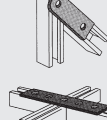
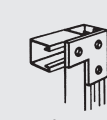
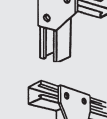
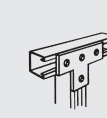
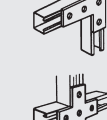
## Wizard® Hardware

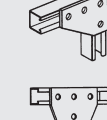
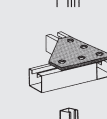
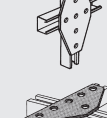
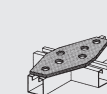
-  No Spring Series
-  Short Spring Series
-  Regular Spring Series
-  Long Spring Series
-  GTSN Series
-  GHH Series
-  GLW Series
-  GFW Series
-  GHN Series
-  GFH Series
-  GRH Series
-  GSN Series
-  GAT Series
-  GRC Series

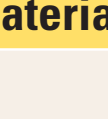
## Wizard® Wing Fittings

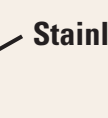
-  G-321-L,R
-  G-321-12 Series
-  G-326
-  G-326-1
-  G-327
-  G-327-1
-  G-328-1
-  G-329
-  G-329 Series
-  G-330 Series
-  G-331
-  G-332
-  G-333
-  G-334
-  G-335



## Wizard® Flat Plate Fittings

-  G-201 Series
-  G-202 Series
-  G-203 Series
-  G-205
-  G-205-1
-  G-206 Series
-  G-207
-  G-207-1
-  G-208
-  G-210
-  G-211
-  G-212
-  G-213
-  G-214
-  G-216
-  G-217
-  G-218
-  G-219
-  G-219-1
-  G-220
-  G-221
-  G-222

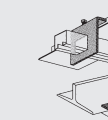
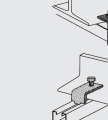
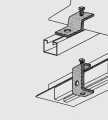
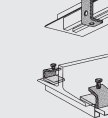
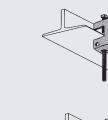

## Wizard® Angle Fittings

-  G-301
-  G-302
-  G-303 Series
-  G-304
-  G-305-1
-  G-306
-  G-306-Series
-  G-307-1
-  G-308
-  G-309
-  G-310
-  G-311
-  G-312
-  G-313
-  G-314
-  G-315
-  G-315-1
-  G-317 Series
-  G-319 Series
-  G-320 Series
-  G-3200 Series
-  G-322
-  G-323 Series
-  G-323 Series

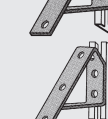
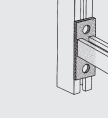
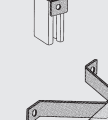

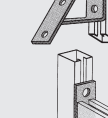
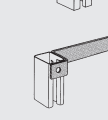
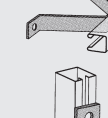
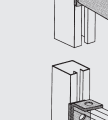
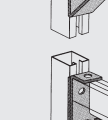
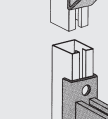
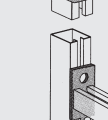

## Wizard® Beam Clamps

-  G-401
-  G-402
-  G-402-1
-  G-403
-  G-406
-  G-407
-  G-407-1
-  G-408 Series
-  G-410 Series
-  G-411 Series

## Wizard® Brackets & Supports

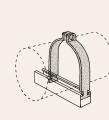
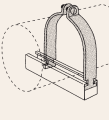
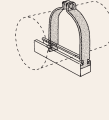
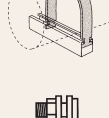
-  GM-601
-  GM-602
-  GT-612 Series
-  GM-610 Series
-  GM-611 Series
-  GT-613 Series
-  GT-615
-  GT-616
-  GT-617 Series
-  GT-618 Series

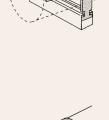
## Wizard® Clamps

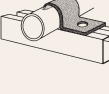
-  EMT GC110 Series 3/8" to 2"
-  Rigid GC112 Series 3/8" to 10"
-  Universal GC114 Series 3/8" to 2"
-  O.D. Tubing GC111 Series 1/4" to 8"
-  Cushion-Tube GC1 Series 1/4" to 4-1/8"
-  Cushion-Pipe GC2 Series 1/4" to 6"
-  O.D. Tube GC111 Copper Series 1/4" to 8"
-  Pipe Strap G1108 Series 1/2" to 8" 2-hole
-  Tubing Clamp G1109 Series 1/4" to 1" 1-hole

## Wizard® Support Systems

-  G-154 Series
-  GPP Series

## Perforation Dimensions

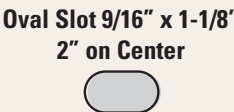
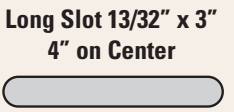
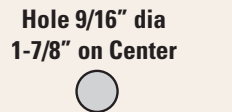
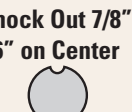







-  Oval Slot 9/16" x 1-1/8" 2" on Center
-  Long Slot 13/32" x 3" 4" on Center
-  Hole 9/16" dia 1-7/8" on Center
-  Knock Out 7/8" 6" on Center

All channels are 1-5/8" Profile (width) x the following depth: Length: 10', 20', 6'-8" or virtually any custom size

### 12 Gauge

\*Note: Profiles shown smaller than actual size

### 14 Gauge



- |   |   |   |   |   |   |   |   |   |
|---|---|---|---|---|---|---|---|---|
|  |  |  |  |  |  |  |  |  |
| G-812<br>3-1/4"   | G-712<br>2-7/16"  | G-582<br>1-5/8"   | G-382<br>1-3/8"   | G-102<br>1"   | G-132<br>13/16"   | G-782<br>7/8"   | G-584<br>1-5/8"   | G-134<br>13/16"   |







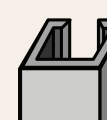
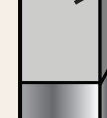

G-STRUT® METAL FRAMING DIVISION

Gregory Industries, Inc. • 4100 13th Street, SW • Canton, Ohio 44710  
Call 866-997-8788 • Fax 330-477-0626 • www.gstrut.com

## Material

-  Steel
-  Stainless Steel
-  Aluminum
-  Fiberglass

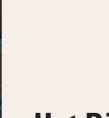
## Finish

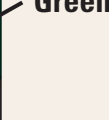
-  Pre-galvanized
-  Hot Dipped
-  Green
-  PVC Coat
-  WIZCoat™ Galvanneal
-  Plain
-  Gold
-  Custom Colors

